

7 U H Q F K 0 2 6 % D U U L H U 6 F K R W W N \ 5 H

Features

- ‡ \$ G Y D Q W U H G Q F K W H F K Q R O R U \
- ‡ / R Z R U Z D Y R G W D J H G U R S
- ‡ / R Z R Z I O R V V H V
- ‡ + L J H I L F L H Q F \ R S H U D W L R Q
- ‡ / H D G H H L Q L V K & R P 6 O L D Q W

Applications

- ‡ ' & ' & & R Q Y H U W H U V
- ‡ \$ & ' & \$ G D S W R U V
- ‡ 6 Z L W F X R Q H X S S O L H V
- ‡) U H H Z K H H L Q G Q J

Maximum ratings and electrical characteristics (TJ = 25°C unless otherwise noted)

| 3 D U D P H W H U | 6 \ P E R O | / L P L W | 8 Q L W |
|--|---------------------------------|-----------|-----------|
| 0 D [L P X P H S H V S H M U N Y Y H Y U R O W D J H | 9 5 5 0 | | 9 |
| 0 D [L P X P Y H U D R U H Z D U G U F X E W H I Q W G | ,) \$ 9 | | \$ |
| 3 H D N I R U V Z D U F S U U H Q W V L Q D O H Q Z D Y H V X S H U L P S Q M H V C H R S E G L R G H | ,) 6 0 | | \$ |
| 2 S H U D M X Q E D Q L Q W R U D J H W D E S H U D W X 0 H 7 6 7 * | | 5 W R | |
| 7 \ S L F D O W K H U P D O U H V L V W D Q F H S H U | G L S G H 0 R X Q W H G R Q) 5 | | 3 & f % : |

7 < 3 0 \$;

, Q V W D Q W D Q H R R 0 W R U Z D U G
S H G L R G H

9)

1 R W H V

3 X O V H W H V V S X O V H Z L G W K G X W \ F \ F O H

3 X O V H W H V W 3 X O P W H Z L G W K 0

RATINGS AND CHARACTERISTICS CURVES (TA = 25 °C unless otherwise noted)

Y H U D J H) R U Z D U G & X U U H Q W ' H U D W L Q
 S Q W , Q V W D Q W D Q H B & X U B I E S Z D V
 W

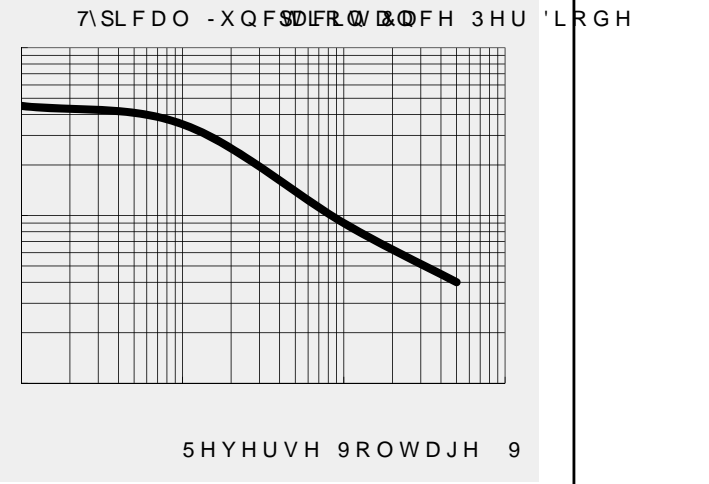
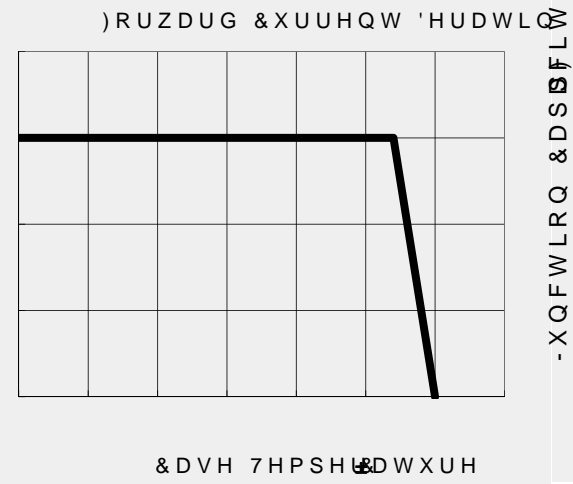
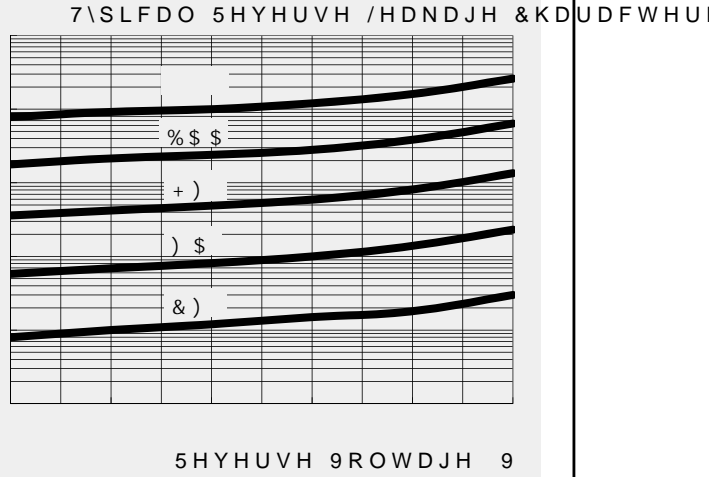
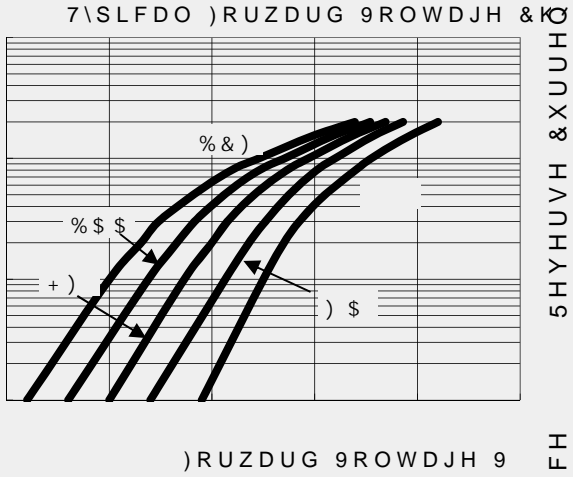

3 \$ & . \$ * (287 / , 1 (' , 0 (16 , 2 1 6

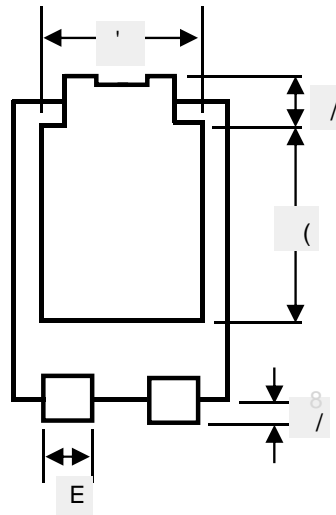
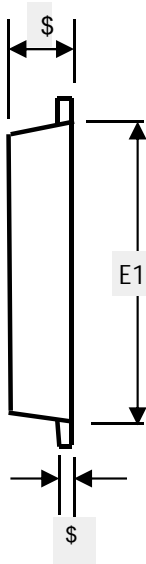
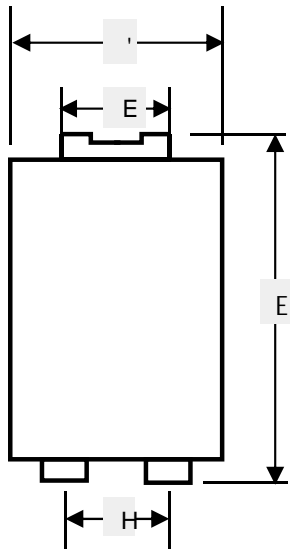

8, 1° ÄQ...49™ E 1

72

81,7

Marking Information

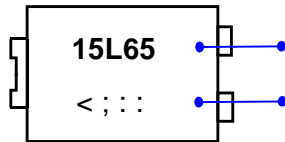

3 URGXFW PRGHO 7 6 315L65SP 5 HIHUUH
WR DV 15L65

3' & LQIRUPDWLRQ

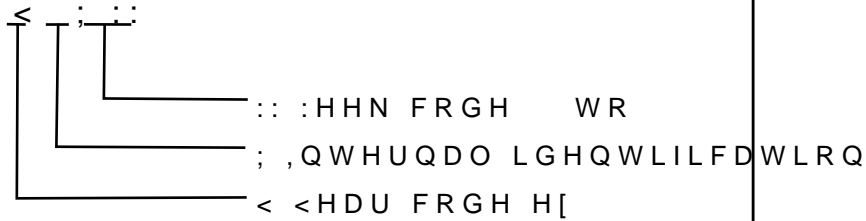

Packaging Information

5HHO 'LPHQVLRQV

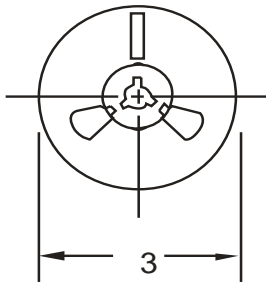

,QVLGH %R[

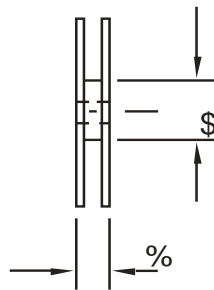

2XWVLGH %R[

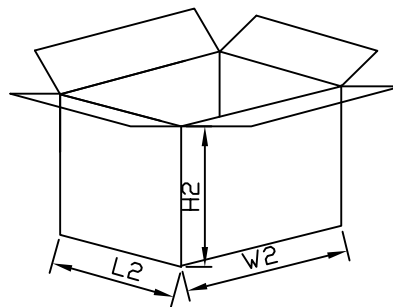
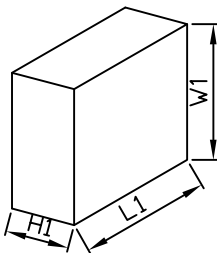

Packaging Information

| 12 | 81,7 | 5HHO'PHQVLRQV | ,QVLGH% | 2XWVLGH %R[|
|------|------|------------------|----------|---------------|
| 6L]H | PP | \$ | % | / : + |
| 47< | 3&6 | 6PDOOHVW SDFNDJH | 3&6 UHHO | 3&6&6HFDOWRWR |
| 1RWH | | 7ROHUDQFPP" PP | PP" PP | PP" PP |