

7UHQFK 026 %DUULHU 6FKRWWN\ 5H

)HDWXUHV

‡ \$GYDQWUHQFK WHFKQRORJ\

‡ /RZRUZDURGDWDJH GURS

‡ /RZRZURVVHV

‡ +LJHILFLHQF\ RSHUDWLRQ

‡ /HDGH)HLQLVK &RPSOLDQW

\$SSOLFDFWLRQV

‡ '& '& &RQYHUWHUV

‡ \$& '\$GDSWRUV

‡ 6ZLWFKRZLSSOLHV

‡ )UHHZKHHLRGLJ

0D[LPXP UDWLQJV DQG HOHFWULFDJ&FXODDWHVHUQRWHIGFV

3DUDPHWHU		6\PERO	/LPLW	8QLW
0D[LPXPHSHVSHUNYYHYURQWDJH		9550		9
0D[LPXPYHUDRHZDUG UHXJWHIQWG		,) \$9		\$
3HDN IRUZDURSUHQW VLQRDWHQZDYH VXSHULP&DWHQRSGGLRGH		,)60		\$
2SHUDMXQRDQRWRUDJH WDRSHUDW		XUH 767	WR	
7\SLFDO WKHUPDO UHVLVWDQFH SHU		G5R&H	ORXQWHG RQ )5	3&f% :
,QVWDQWDQHRRQWRDURZDUG SHGLRGH	,) \$	7- f&	7<3	0\$;
	,) \$	7- f&		
	,) \$	7- f&		9
,QVWDQWDQHRXUUSHQWRDWH UDWHYHYURQWDJH	7- f&	,5		X\$
	7- f&			P\$

1RWHV

3XOVH WHVVSXOVH ZLGWK GXW\ F\FOH

3XOVH WHVW 3XOVH ZLGWK 0

5 \$ 7 , 1 \* 6 \$ 1 ' & + \$ 5 \$ & 7 ( 5 , 6 7 , & 6 & 7 8 5 9 ( 6 f & X Q O H V Q R W K B U Z L V H

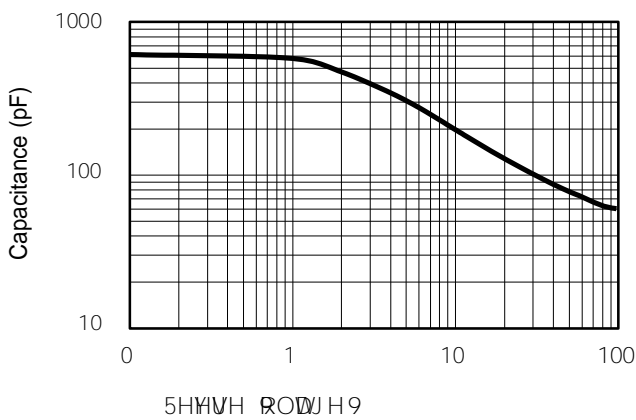
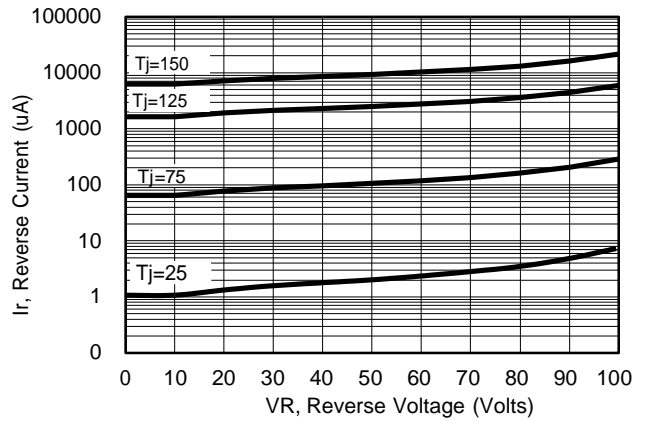
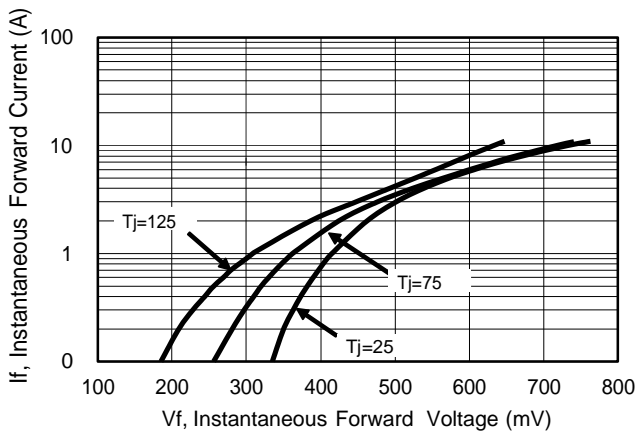
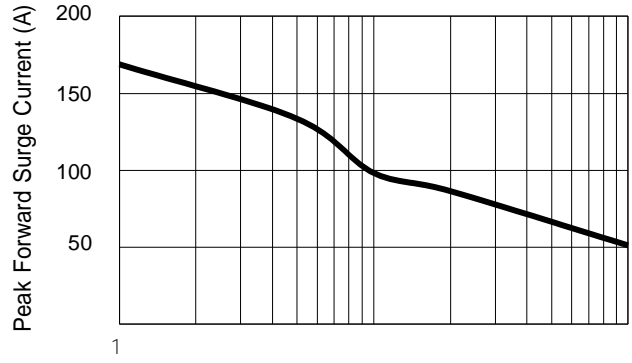
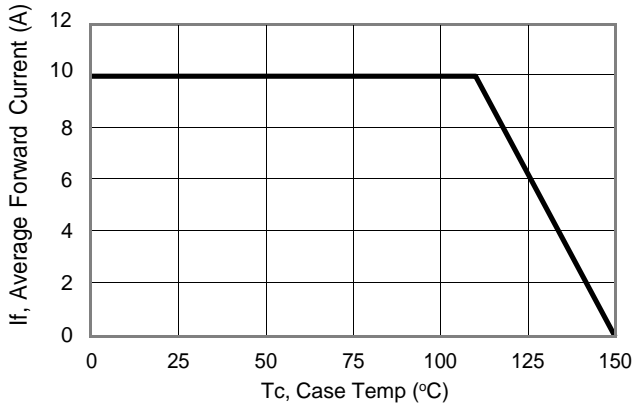

3 \$ & . \$ \* ( 2 8 7 / , 1 ( ' , 0 ( 1 6 , 2 1 6

7 2

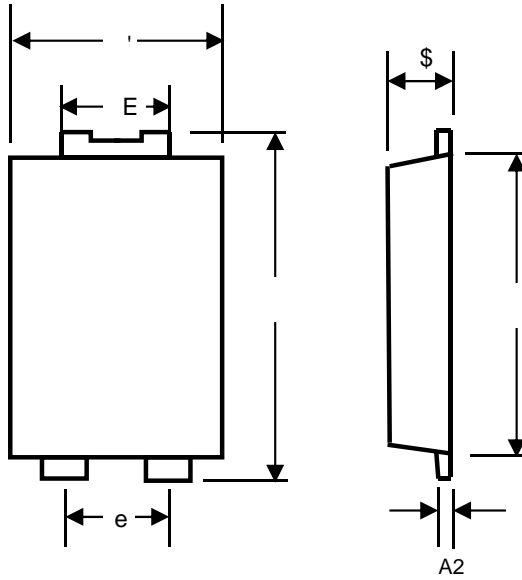

0DUNLQJ ,QIRUPDWLRQ

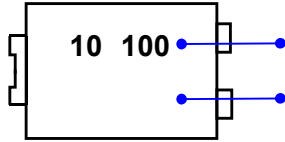

3URGXFW PRGHO 763 / 63 5HIHUL  
WR DV \$  
3' & LQIRUPDWLRQ

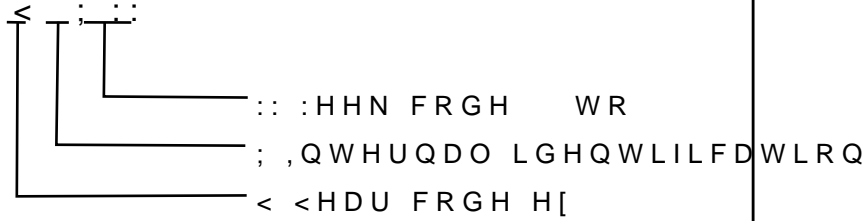

3DFNDJLQJ ,QIRUPDWLRQ

5HHO 'LPHQVLRQV

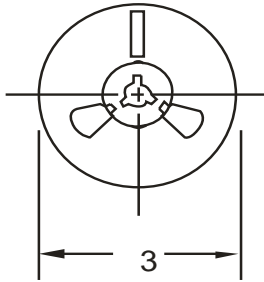

,QVLGH %R[

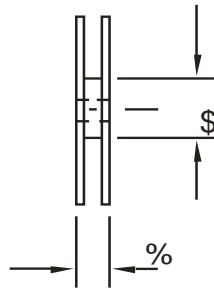

2XWVLGH %R[

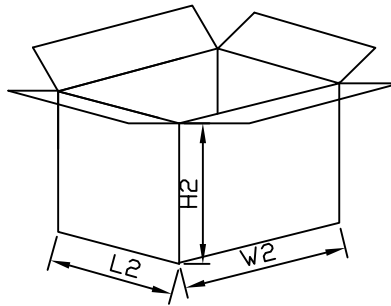
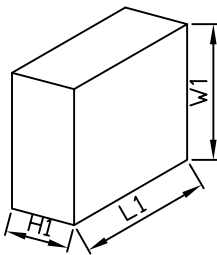

3DFNDJLQJ ,QIRUPDWLRQ

12	81,	5HHO 'LPHQVLR	,QVLGH %R[	2XWVLGH %R[
6L]H	PP			