



TSP10V150SP

7UHQFK 026 %DUULHU 6FKRWWN

TSP10V150SP

TO-277

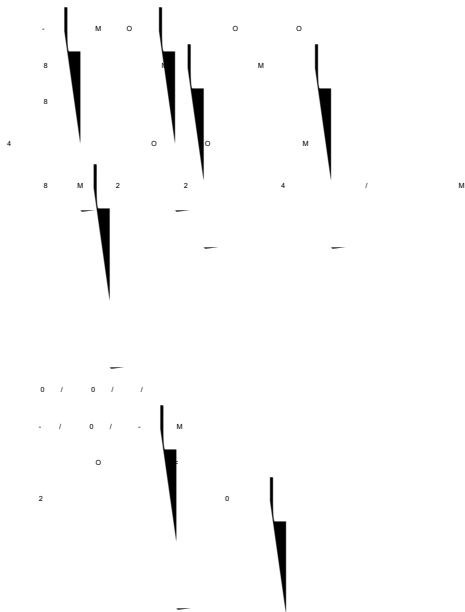
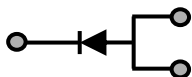

< M M		N	B	A
3 M M M M		B B		B
3 M M M M O O		52 - B		
1 M M M M M M		52 9		
1 M M M M M M		B B B 1		
7 \ S L F D O W K H U P D O U H V L V W D Q F H S H U G L R G H O R X Q W H G R C ) 5 .		3 & %		
		B E *		
		B 2 0		
		7 - &		
		5		



# TSP10 V1 50SP

, I \$ Y H U D J H ) R U Z D U G & X U U H Q W

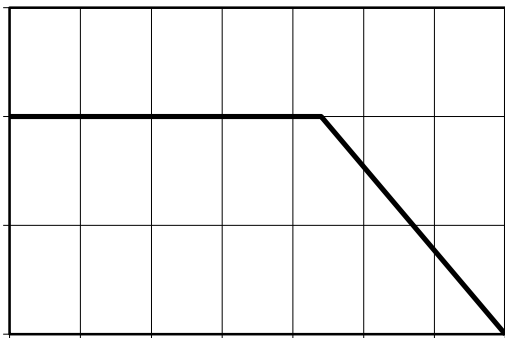

7F & DVH 7HPS

$\mu$   $\text{C} \text{C} \text{v} \check{s}$   $\text{C} \check{s}$  ] v P U

7\$ f & X Q O H V \ Q R W K B U Z L V H

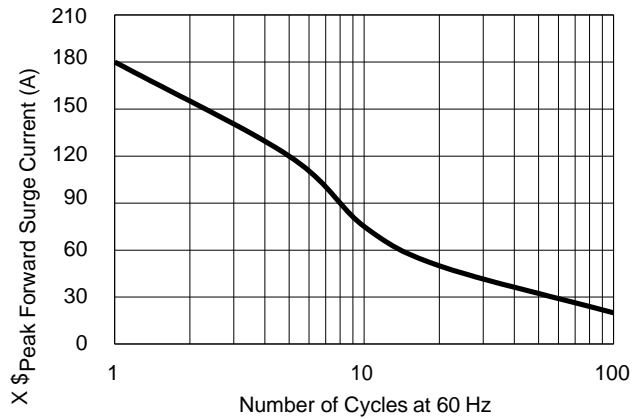

, I , Q V W D Q W J R Q W J Z R B X W J U H Q W

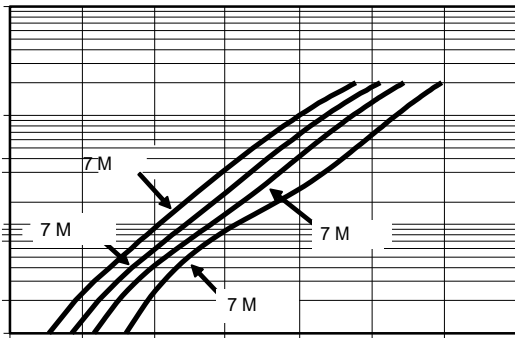

91 , Q V W D Q W D Q H R X W J D R J U Z D P U G

d  $\check{C}$  % ] o & }  $\text{C} \check{A}$   $\text{C} \check{s}$  } o  $\check{s}$  P

, U 5 H Y H U V H & X U U H Q W

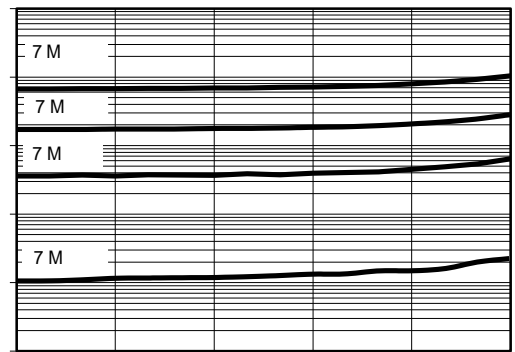

95 5 H Y H U V H 9 R O W D J H 9 R O W V

d  $\check{C}$  % ] o Z  $\check{A}$   $\text{C} \check{s}$  •  $\mu$   $\text{C} \text{C} \text{v} \check{s}$

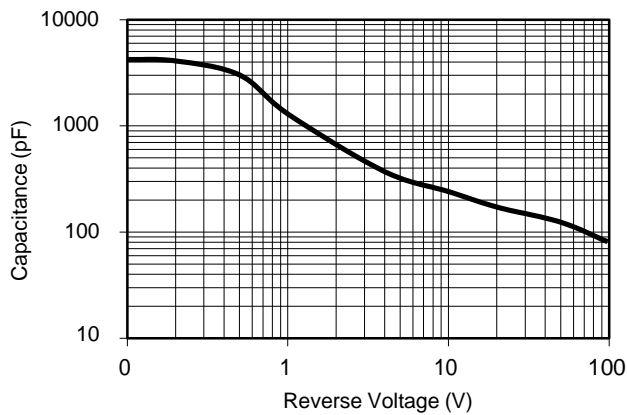

d  $\check{C}$  % ] o :  $\mu$  v  $\check{s}$  ] } v % ]  $\check{s}$  v

72

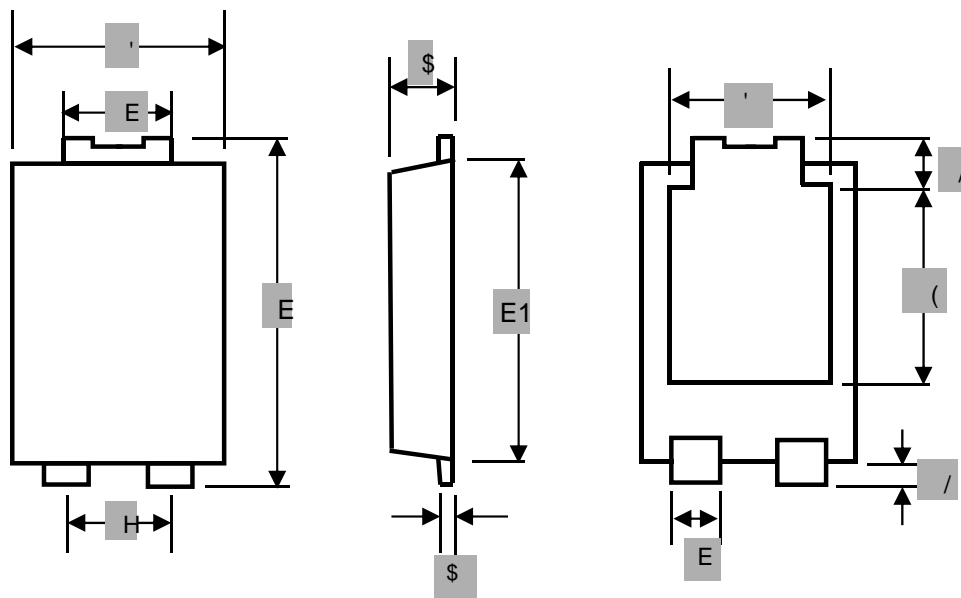

72 PHFKDQLFDO GDWD

72

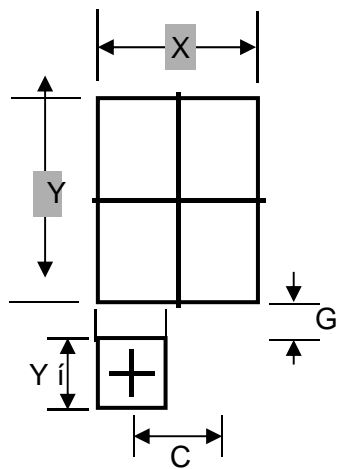

81, 7		&	*	;	;	
PP	PLQ					
PLQ	PLQ					

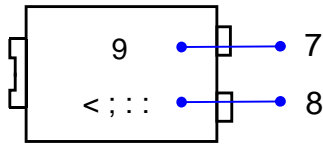

7. W P D V 9  
8. / M Æ

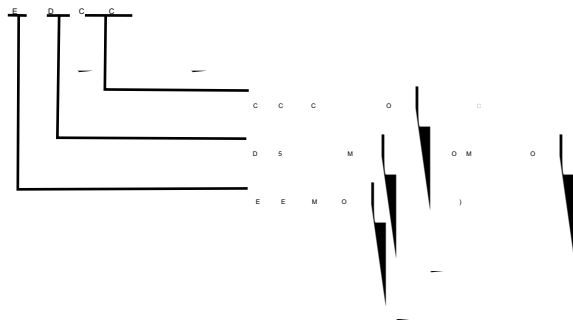

5HHO 'LPHQVLRQV

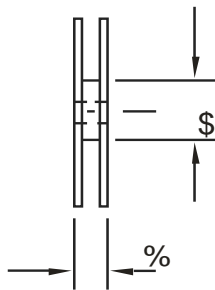
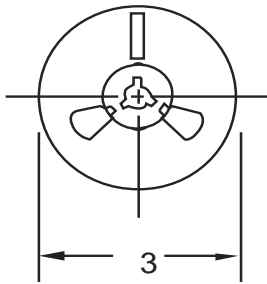

,QVLGH %R[

2XWVLGH %R[

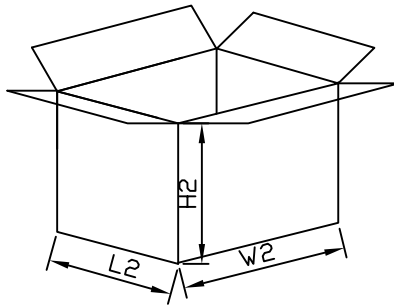
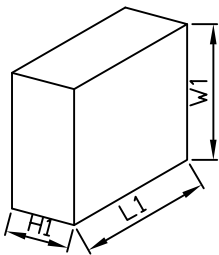

12	81,	5HHO 'LPHQVLR			,QVLGH %R[			2XWVLGH %R[		
6L]H	PP	&	\$	%	/	:	+	/	:	+
47<	3&6	6PDOOHVW SDFNDJH			3&6 UHHO			3&6&6 HFOVLRQV WDO		
1RWH		7ROHUDQFH PP" PP			PP" PP			PP" PP		